



PUNA hexapod

Simple and affordable hexapod



KEY FEATURES

- Payload capacity up to 25 kg
- Resolution 0.5 μm
- Linear travel range ± 30 mm
- Height in middle position 200 mm



APPLICATIONS

- Instrumentation
- Optics
- Testing laboratories
- Synchrotrons
- Aeronautics and spatial
- Metrology
- Semiconductors
- Automotive



PUNA hexapod in motion



PUNA	
Motion and positioning	
Travel range Tx, Ty (mm)	± 30
Travel range Tz (mm)	± 20
Travel range Rx, Ry (deg)	± 11
Travel range Rz (deg)	± 20
Resolution Tx, Ty, Tz (µm)	0.5
Resolution Rx, Ry, Rz (µrad)	5
Repeatability Tx, Ty, Tz (µm)	± 0.75
Repeatability Rx, Ry, Rz (µrad)	± 3.2
Speed Tx, Ty (mm/s)	3
Speed Tz (mm/s)	1.25
Mechanical properties	
Stiffness X, Y (N/µm)	1.75
Stiffness Z (N/µm)	30
Payload capacity (kg) (vertical orientation / horizontal orientation)	25 / 10
Motor type	DC
Miscellaneous	
Operating temperature range (°C)	0 to + 50
Materials	Aluminum, steel, stainless steel
Size mobile platform (mm)	Ø 250
Central aperture (mm)	Ø 100
Height in middle position (mm)	200
Mass (kg)	5.6
Cable length (m)	3
Options	Clean room compatibility
Controller	
Controller type	NAOS or ALPHA
Interface	Ethernet
Power supply	110-240 VAC / 50-60 Hz

Datasheet subject to change without notice. All data are superseded by any new release. R190731

The performances are specified for single axis motions, with all other axes at midrange and for a rotation center in the middle of the mobile platform.

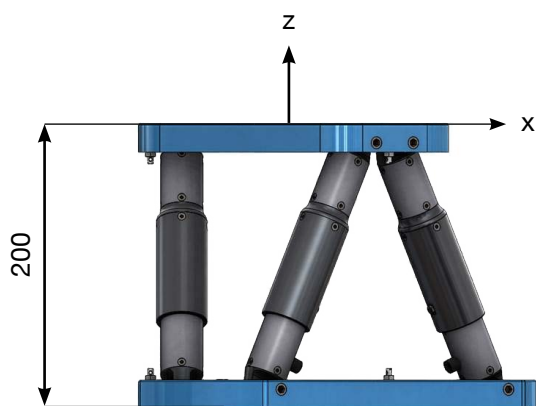

Hexapod in middle position

