

Lambert 

LIFA

FLIM system

Experiments from start to finish

From recording images to lifetime calculation and data analysis.

Fast lifetime imaging

Up to 30 lifetime images per second in siFLIM mode.

Broad lifetime range

From picoseconds to microseconds.



Why FLIM?

Fluorescence Lifetime Imaging Microscopy (FLIM) is gaining interest as a tool to assess the biochemical environment of fluorescent molecules/probes. Upon excitation, fluorescent molecules emit light and the fluorescence lifetime quantifies the decay rate of that emitted light. The fluorescence lifetime is a telltale signature of the molecules and their immediate environment.

FLIM is the technique to map the spatial distribution of lifetimes in living cells and in inorganic material. A key advantage of the fluorescence lifetime over the light intensity is that fluorescence lifetime is independent of concentration, bleaching and intensity variations, making it an inherently quantitative technique.

Applications

- Molecular interactions
- Protein conformation
- Biosensors
- Oxygen imaging
- Protein-protein interactions
- Ion imaging
- NADH/FAD fluorescence dynamics
- Viscosity imaging
- Membrane dynamics
- Membrane trafficking
- LED inspection
- Crude oil characterization
- Solar cell MCL monitoring

The LIFA is compatible with

- Widefield fluorescence microscopes
- Total Internal Reflection Fluorescence
- Spinning-Disk Confocal
- Hyperspectral imaging

The LIFA

The LIFA is a camera-based FLIM system for fast fluorescence and phosphorescence lifetime imaging. Its well-established frequency-domain detection technology offered by the Toggel modulated camera allows near instantaneous acquisition of lifetime images with high accuracy.

As it is a camera-based system the LIFA is especially well-suited for live cell imaging. The standard, widefield system includes a Multi-LED modulated light source with high-power LEDs. Using a Multi-LASER engine it can be easily combined with Total Internal Reflection Fluorescence (TIRF) for TIRF-FLIM, and with multi-beam confocal spinning disk, for confocal FLIM.

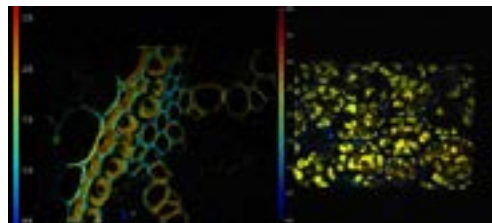

Spinning-disk confocal FLIM images of plant samples.

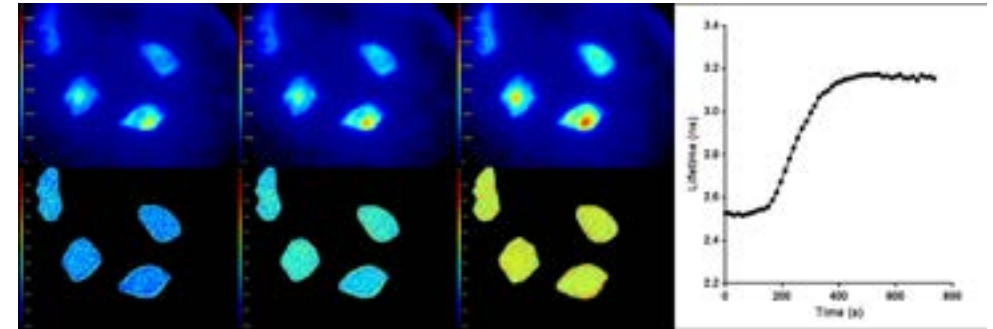

Top row: Light intensity images (colorized). Bottom row: Corresponding fluorescence lifetime images (colorized). The average fluorescence lifetime of the cells increases over time, as shown in the graph on the right. Image courtesy of the Netherlands Cancer Institute.

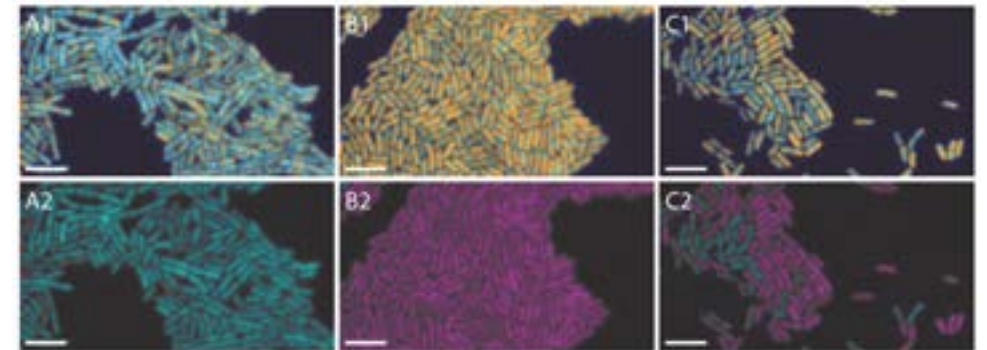

B. subtilis cells showing different lifetimes. Top row: Original lifetime images of FRETing, non-FRETing and mixed cells. Bottom row: Same cells as top row, but categorized and colored based on average cell lifetime. Scale bar is 5 μm . Image courtesy of University of Groningen [2].

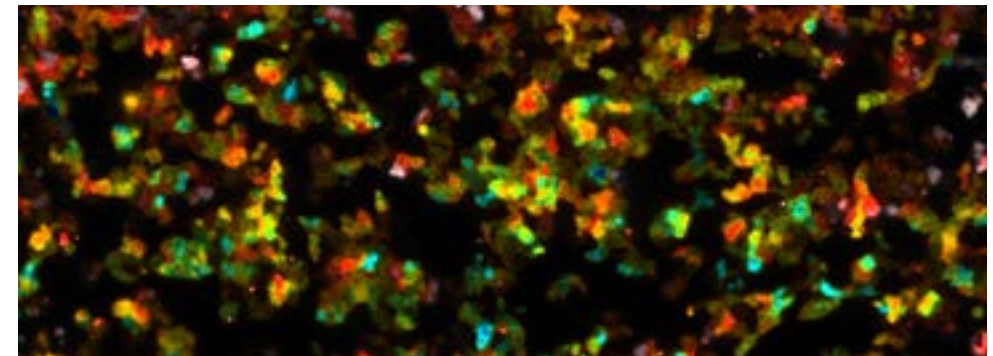

Stitched lifetime images of Hap1 cells expressing EPAC-sensor that shows a lifetime increase when cAMP concentration increases after stimulation with isoproterenol. Image courtesy of the Netherlands Cancer Institute.

How does it work?

In frequency-domain FLIM the fluorescence lifetime of your sample is acquired very rapidly by using a modulated light source (blue curve) and a modulated camera (green curve). Due to the fluorescence decay, the fluorescence emission from the sample (red curve) is phase-shifted and reduced in amplitude.

For both the excitation and the detection the same frequency is used (homodyne detection), and at different camera phase settings (1-5 in the figures on this page) a series of images of the fluorescence emission is taken. This results in a frequency-domain cross-correlation function (bottom picture, red curve) for each of the pixels in the image. The intensity of the emission image will depend on whether the detector sensitivity is partly (2 and 4 in the example) or fully (1 and 5 in the example) in phase with the fluorescence emission.

The key is that this function exactly mirrors the phase shift and the demodulation of the fluorescence emission in the time domain. These two parameters can be translated to a lifetime value per pixel. This frequency-mixing approach is the basis of radio technology and is well known for its convenience, simplicity and strong noise suppression. This fluorescence lifetime is obtained simultaneously for all pixels by using a state-of-the-art modulated camera.

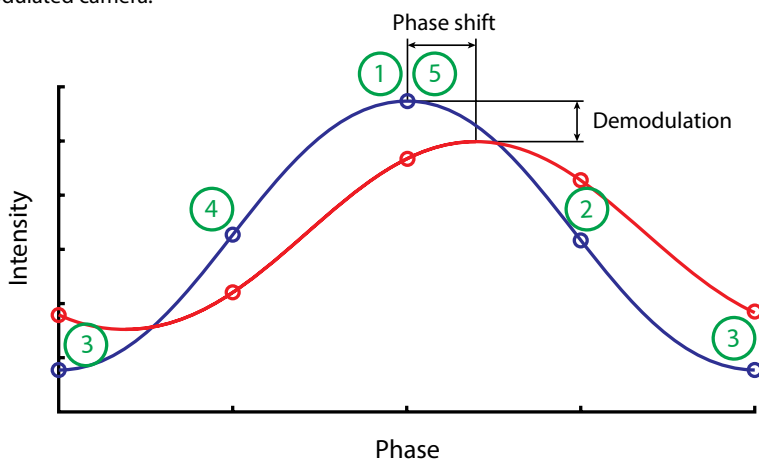
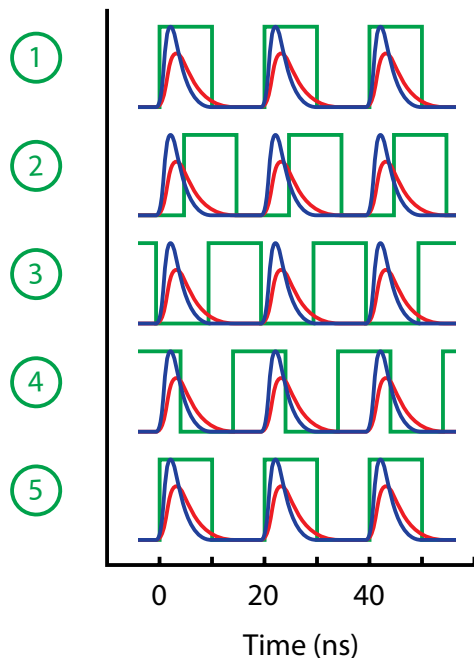

For further analysis the frequency-domain lifetime data can be decomposed into exponential components. A popular alternative is to plot the measured phase shift and demodulation in a single diagram. This phasor plot offers a visual overview of the fluorescence decay in the image.

In the phasor plot the presence of different molecular species or the occurrence of FRET is visualized as data clustering in specific regions. The phasor plot analysis is fast and makes FLIM accessible to the non-expert in spectroscopy and data analysis.

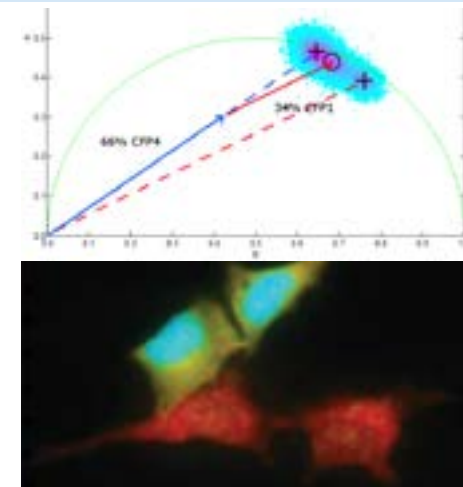

Cells showing localized expression of CFP1 and CFP4, and the corresponding phasor plot. Image and data courtesy of the University of Amsterdam.

Single-image FLIM

The Toggel camera features a unique image sensor that was designed and optimized specifically for fluorescence lifetime imaging applications. It enables lifetime imaging at unprecedented frame rates with the single-image fluorescence lifetime imaging microscopy (siFLIM) method [1].

During a single exposure, the modulated image sensor in the Toggel camera records two images. The electrons in each pixel of the sensor are toggled between two storage areas at the same frequency as the modulation frequency of the light source. This results in two images that are shifted 180° in phase with respect to each other.

The difference in light intensity between these two images depends on the phase shift and demodulation of the fluorescence light and can be used to track changes in the fluorescence lifetime of a sample [1]. A simple calibration is enough to enable video-rate lifetime imaging that is immune to artifacts caused by cellular movements and signal transients because the images are recorded simultaneously.

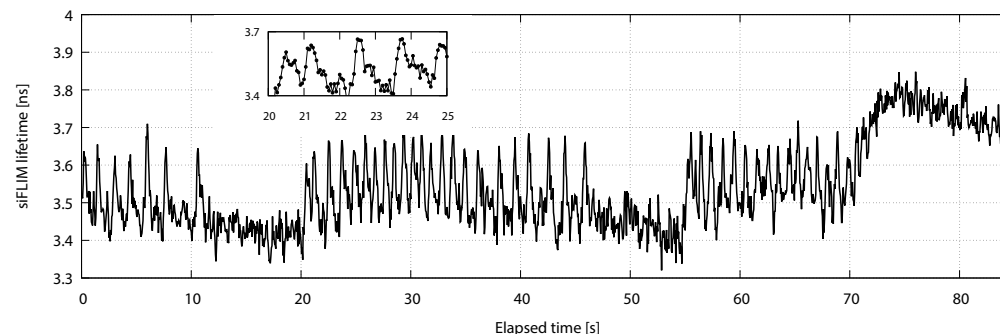

siFLIM detection of histamine-induced alterations in Ca²⁺ concentration at 20 fps. Tiny oscillations in Ca²⁺ levels (~2.5 s periods) are observed after addition of histamine. Data courtesy of the Netherlands Cancer Institute.



Experiments from start to finish

Our LIFA software guides you through your FLIM experiments from start to finish. All Lambert Instruments hardware is integrated seamlessly so you can focus on your experiment. Finding the right FLIM settings is easy with Live View from the camera. The software takes care of recording the FLIM data and instantly calculates the fluorescence lifetime.

Image acquisition

Recording a single fluorescence lifetime image takes less than a second. Our software takes care of acquiring the FLIM data and instantly calculates the fluorescence lifetime.

You can also record a time-lapse video of your sample to see how the lifetime changes over time. Simply set the duration and the interval between images and our software takes care of the rest.

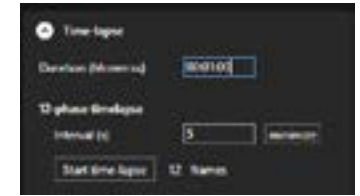

Data analysis

Once you have recorded your FLIM data, the LIFA software automatically calculates the fluorescence lifetime. You can analyze the results as statistical data or in several visual representations including histograms, scatter plots and the phasor plot.

All fluorescence images and graphs can be exported to common image formats or as raw data points. Time-lapses can be exported to video files. Statistics can be copied from the LIFA software and pasted into third-party software like Microsoft Excel.

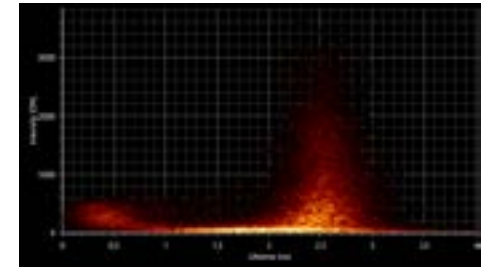
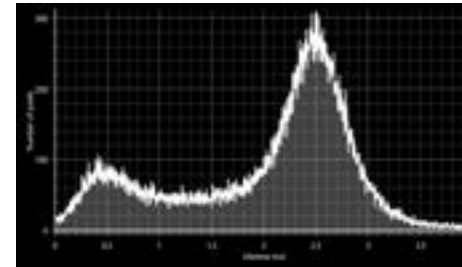

Hardware control and automation

Lambert Instruments light sources can be controlled in the LIFA software. You can switch between wavelengths with a single click.

Third party hardware is also supported. The list of supported microscopes, stages and light sources is expanded regularly. For more information please contact our sales team.

You can also take full control of the LIFA software by using our automation interface. This way, you can adjust all acquisition settings and trigger the camera to record FLIM images and time-lapses from any supported programming environment.

LIFA components

The standard LIFA configuration includes the items below. If your application requires a different configuration then please get in touch with our sales team to discuss your requirements.

Toggel modulated CCD camera
Multi-LED and/or Multi-LASER light source(s)
LIFA software package
Computer with Camera Link frame grabber
Installation by a Lambert Instruments engineer at your lab
One day of hands-on training
Phone, email and remote-desktop support

Widefield configuration

On widefield microscopes, the Toggel camera in combination with the Multi-LED offers a capable yet compact FLIM solution. The Toggel is compatible with the camera port of widefield microscopes and the Multi-LED is compatible with the standard epifluorescence port of widefield microscopes.

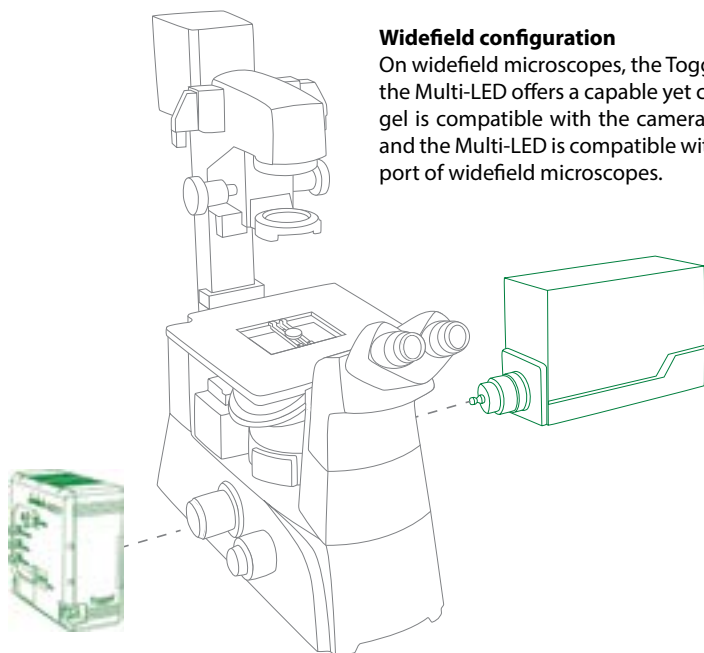

Spinning-disk confocal configuration

Being a camera-based system, the Lambert Instruments LIFA system for frequency-domain FLIM is compatible with multi-beam confocal microscopy techniques, most notably the Yokogawa CSU spinning disk series (based on the Nipkow disk scanner), and the VTInfinity series by Visitech International.

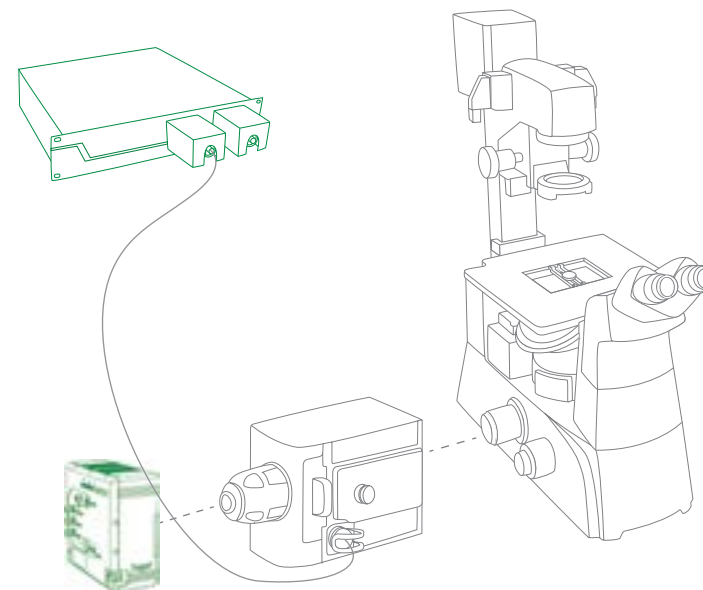

TIRF configuration

Total Internal Reflection Fluorescence (TIRF) microscopy facilitates extremely high-contrast visualization and thereby high sensitivity of fluorescence near the cover glass. Typically, the optical section adjacent to the cover glass is about 100 nm. The unique combination of TIRF and frequency-domain FLIM makes it possible to measure lifetimes of, for instance, small focal adhesions near the cover glass.

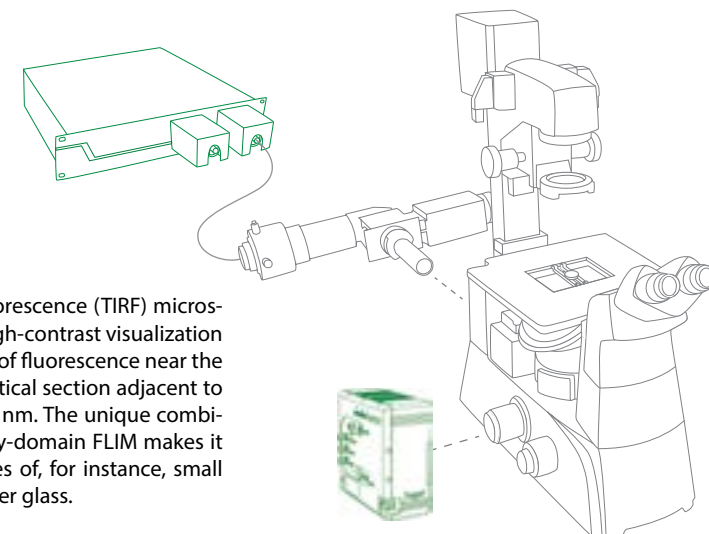

Toggel

The Toggel is a next-generation FLIM camera that simplifies experiments for researchers and imaging centers by combining excellent light sensitivity with easy image acquisition and data analysis.

This camera helps you minimize measurement duration, automate image acquisition and simplify data analysis. These factors are of great importance to many of our customers in cell biology, cancer research and high-throughput screening.



FLIM images Large pixels
30 fps **24 μm**



Parameter	Typical value
Pixel resolution	504 x 512 pixels
Pixel size	24 x 24 μm
Pixel bit depth	14 bit
Full-well capacity	67 000 e-
Readout noise	25 e-
Dynamic range	2 000 : 1 (66 dB)
Dark current	400 e-/s/pixel (at 20° C)
Sensor type	Proprietary CCD sensor
Fill factor	50%
Frame rate	Up to 30 fps (dual images)
Modulation frequencies	13 kHz – 80 MHz
Sensor cooling	Stabilized at 20° C
Camera interface	Camera Link

Features

The Toggel features a unique image sensor that combines excellent light sensitivity with advanced fluorescence lifetime imaging capabilities. This image sensor was designed and optimized specifically for fluorescence lifetime imaging applications and enables lifetime imaging at unprecedented frame rates with the single-image fluorescence lifetime imaging microscopy (si-FLIM) method [1].

Imaging modes of the camera include regular frequency-domain FLIM acquisition and time-lapse recordings. Data analysis is done automatically by the LIFA software, which instantly calculates the fluorescence lifetime and presents it to the user as a colorized overlay on the original image.

Specifications are subject to change without prior notice.

Multi-LED

The Lambert Instruments Multi-LED is a versatile excitation light source for fluorescence lifetime imaging microscopy in the frequency domain. The Multi-LED contains up to 4 LEDs that provide non-phototoxic illumination levels, have a low cost and a long lifespan.

All LEDs are high-quality modulating LEDs with a peak light intensity at wavelengths between 446 and 525 nm, 595 nm, 635 nm and 696 nm. Other wavelengths are available upon request.



Multi-LASER

The Multi-LASER is a light source for frequency-domain fluorescence lifetime imaging microscopy. The Multi-LASER contains up to 6 laser diodes with different wavelengths.

High-speed digital modulation up to 180 MHz, modulation depth of at least 250:1 (standard) or at least 2500000:1 (extreme). Power stability better than 2% (standard) or better than 0.5% (extreme).





Lambert Instruments BV

19 Leonard Springerlaan (fifth floor)
9727 KB Groningen
The Netherlands

www.lambertinstruments.com
Email: sales@lambertinstruments.com
Phone: +31 50 501 8461

References

[1] *siFLIM: single-image frequency-domain FLIM provides fast and photon-efficient lifetime data*, M Raspe, K M Kedziora, B van den Broek, Q Zhao, S de Jong, J Herz, M Mastop, J Goedhart, T W J Gadella, I T Young and K Jalink. *Nature Methods* 13, 501–504 (2016)

[2] *Single Cell FRET Analysis for the Identification of Optimal FRET-Pairs in Bacillus subtilis Using a Prototype MEM-FLIM System*, R G J Detert Oude Weme, Á T Kovács, S de Jong, J W Veening, J Siebring, O P Kuipers. *PLoS ONE* 10(4): e0123239. doi:10.1371/journal.pone.0123239